

CHICAGO

AIRPORTS

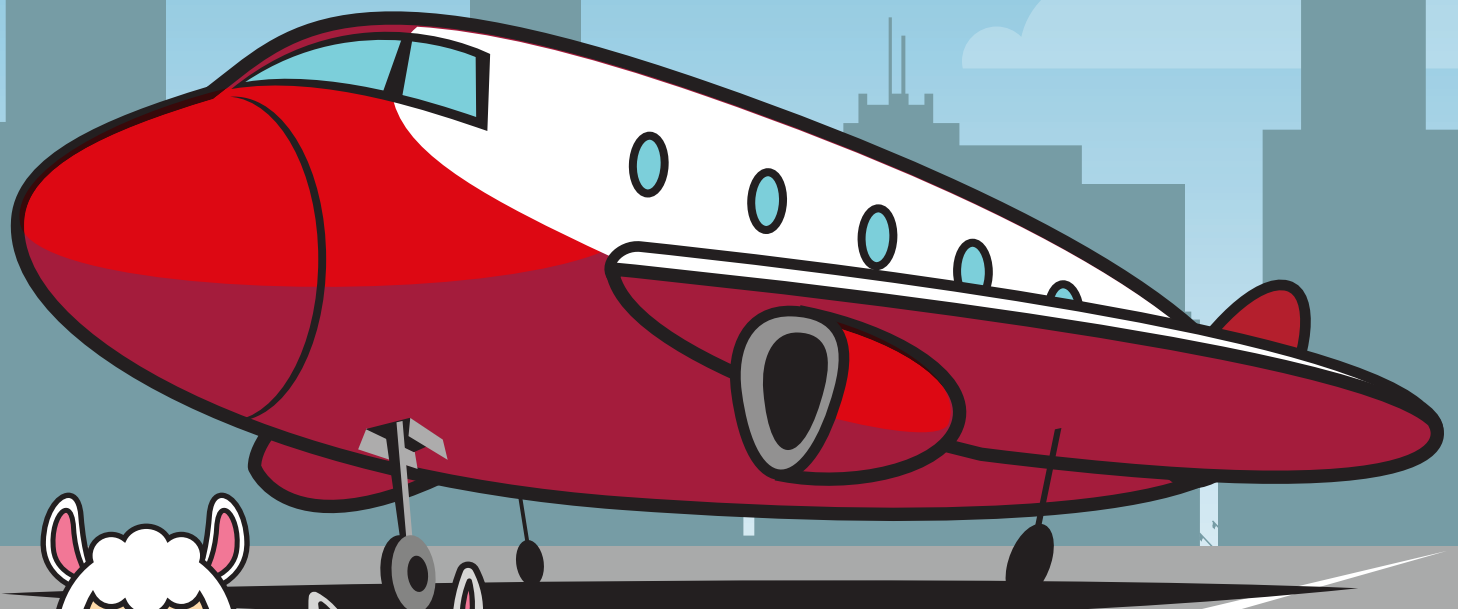

Activity & Coloring Book



This book belongs to:

WELCOME!

Hello young traveler! Welcome to Chicago's great airports. They are world-famous airports for a world-class city. We hope you take a moment to explore the shops, restaurants and more before you head off on your adventure.

The people who work here are the best. They are all ready to help you and your family get to your destination. Look around for the pilots, flight attendants and ticketing agents, as well as food servers, wheelchair transporters, security officers and so many more helpers. And who knows — maybe one day you could work at an airport too.

Wherever you are heading — we hope you have a fun and safe trip!



Mayor,
City of
Chicago
Brandon Johnson

First Lady, City of Chicago
Stacie Johnson

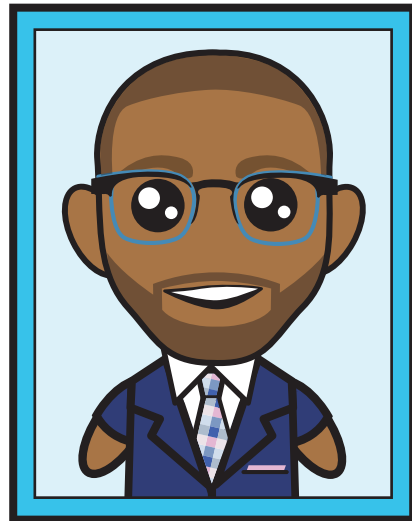

Commissioner,
Chicago Department
of Aviation
Michael McMurray

Welcome to O'Hare and Midway International Airports! You're just in time to tag along on a fun-filled adventure of games, puzzles and coloring! Along the way, you're going to learn all about Chicago's two airports.

You're probably in one of these airports right now. Maybe you're in O'Hare International Airport, one of the world's busiest airports. Every hour, hundreds of planes take off or land here, so people can get to where they want to go. Or maybe you're at Midway, the "busiest square mile in aviation." Wherever you find yourself, the CDA is going to ensure that you and your family have a safe, secure and fun travel experience at the airport. There's something for everyone at Chicago's airports.

Now, hop in your imaginary plane and explore the airports! We hope to see you again soon.

AIRPORT SCAVENGER HUNT.

Airplane

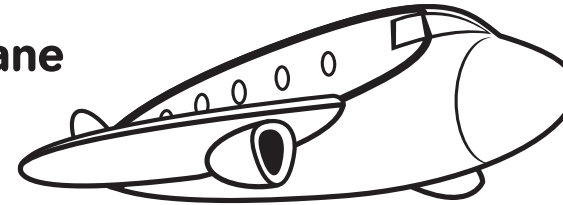

Pilot



Backpack

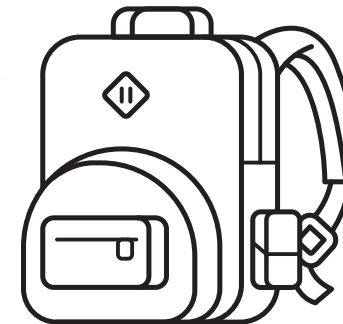

Passport



**Security
Scanner**

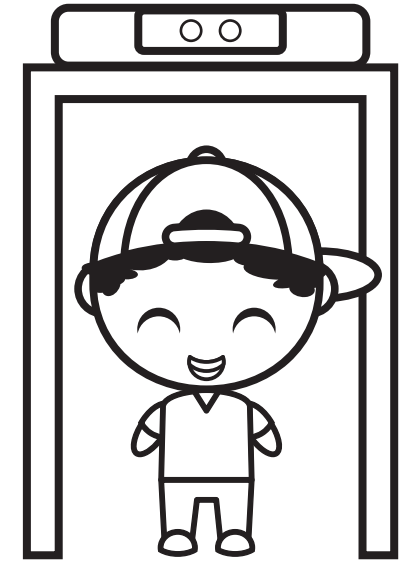

Tickets



**Boarding
Gate**

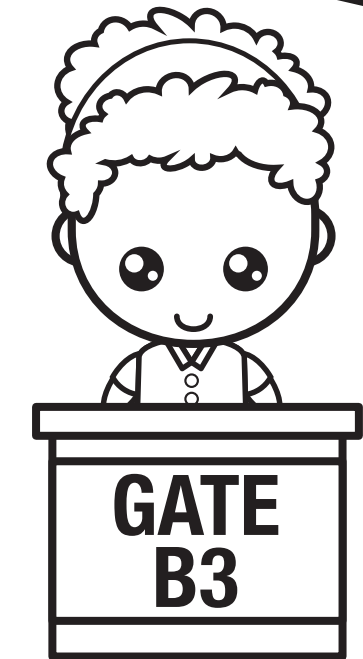

THINGS ABOUT PLANES

& AIRPORTS TO LEARN.

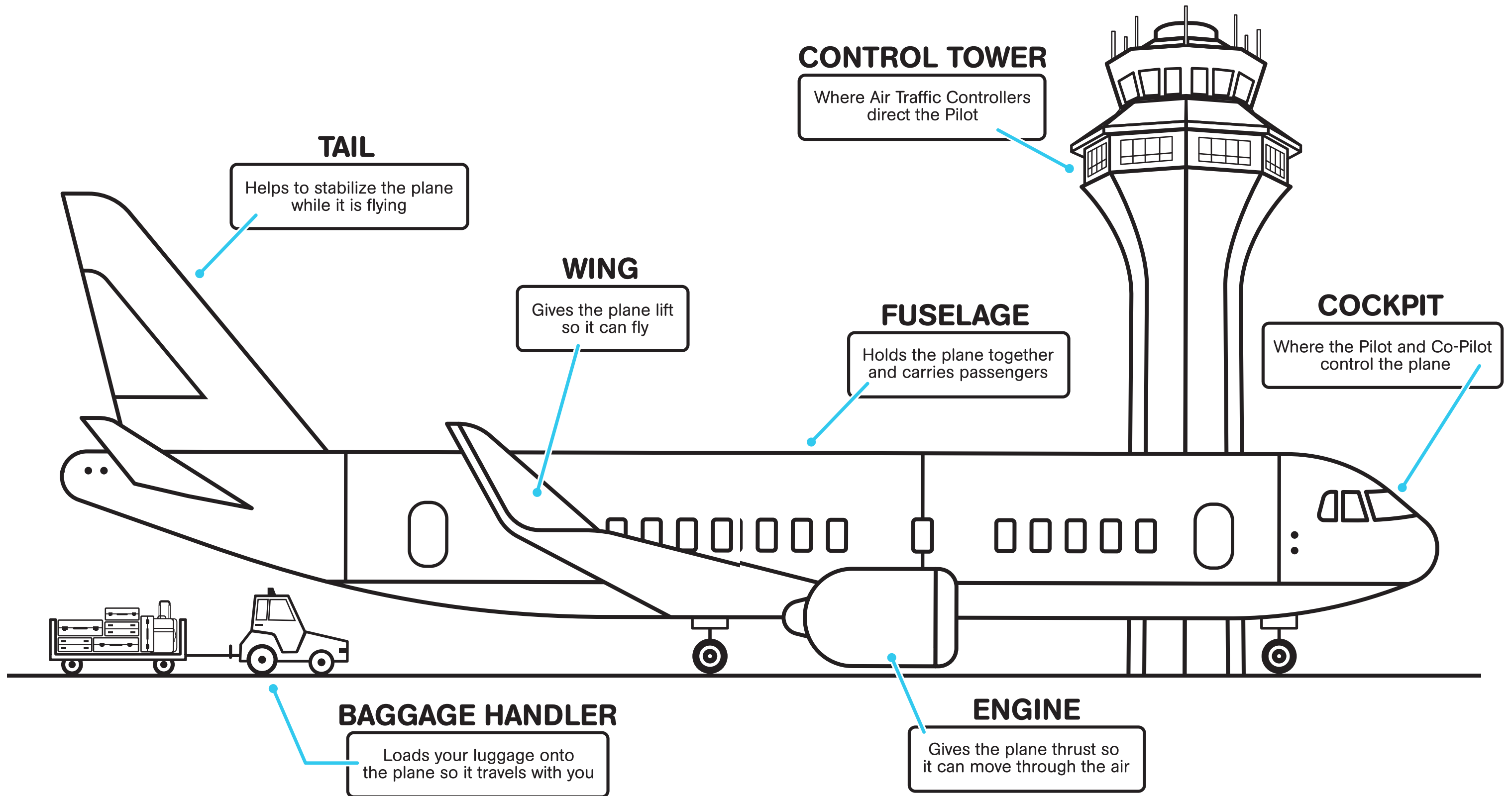

WHICH CAREER LOOKS

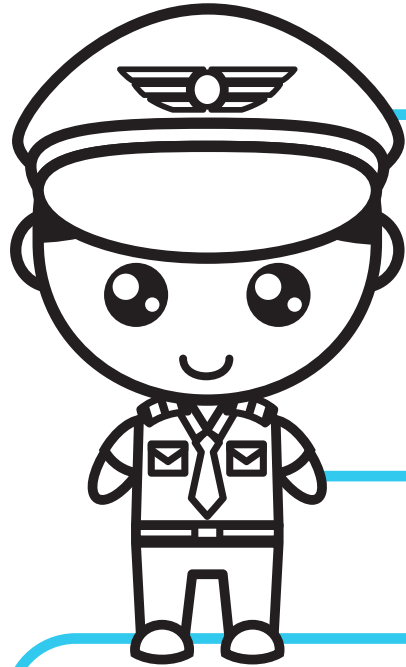

PILOT

They safely fly the plane. Did you know most flights have two pilots? There are the Captain, who is in charge, and the Co-Pilot, who is called the First Officer. Do you want to learn how to fly?

AIR TRAFFIC CONTROLLER

They help pilots take off, fly and land safely. They also direct planes in the air and keep each plane a safe distance from one another. Can you spot an air traffic control tower at the airport?

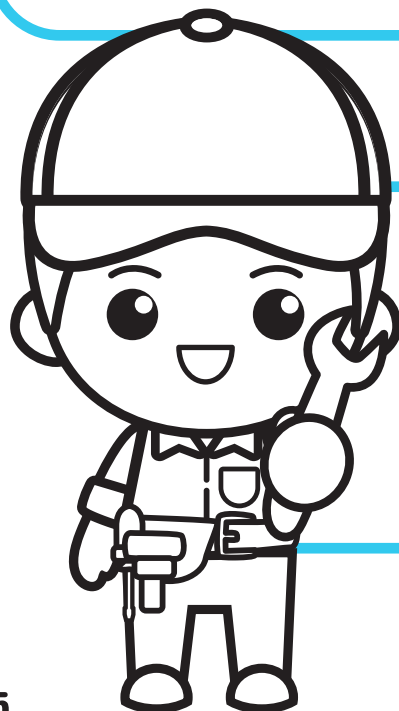

AIRCRAFT MECHANIC

They inspect, test, repair and maintain the planes so they are safe to fly. Do you know all the parts of a plane? They know how to fix engines, landing gear, brakes, the controls and more.

INTERESTING TO YOU?

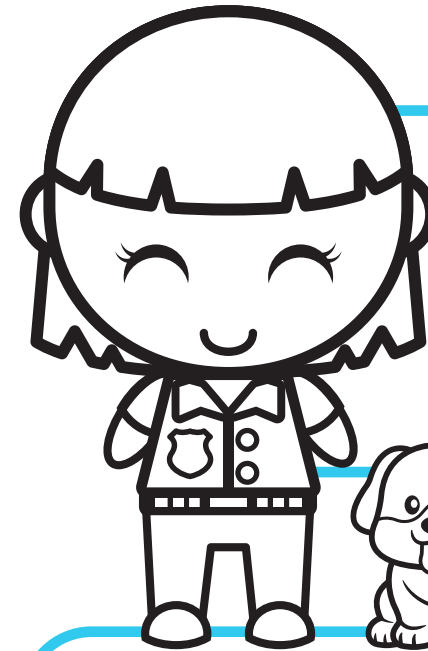

SECURITY OFFICER

They keep passengers and employees safe in the airport. One of them checked your ticket when you came through the security checkpoint. Can you spot any security officers with a dog?

FLIGHT ATTENDANT

They keep passengers on the plane safe and help you feel comfortable during the flight. Did your flight attendant show you how to use a seat belt? Did they serve you a snack or drink on the flight?

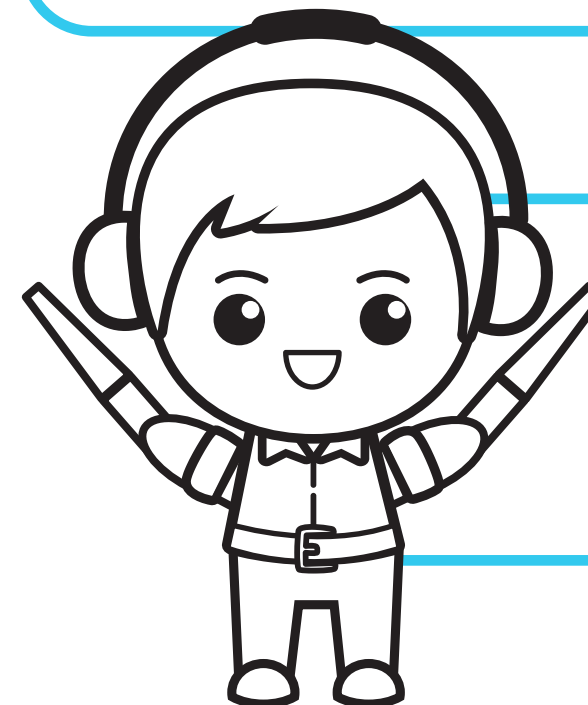
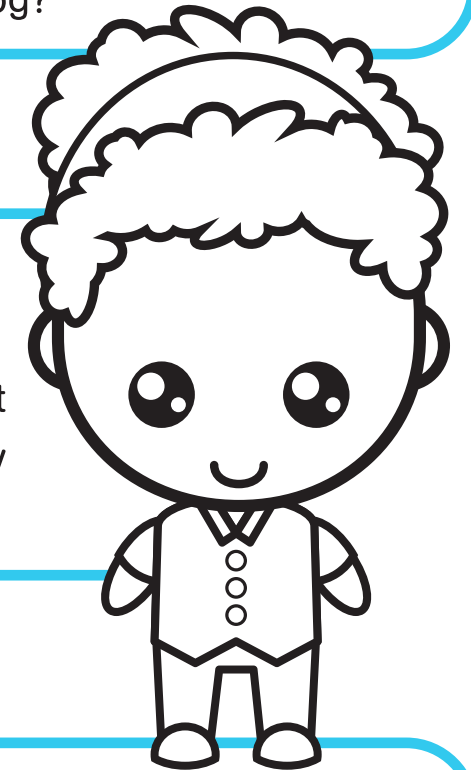

RAMP AGENT

They load and unload your baggage on the right plane, direct planes on the ground between the gates and runway, and help deice (defrost) the plane when it's cold.

MATCH THE TOOLS.

Over 260 skilled trade workers at O'Hare and Midway build and fix our buildings, airport grounds and runways. Can you draw a line from the airport worker to the items they would use?

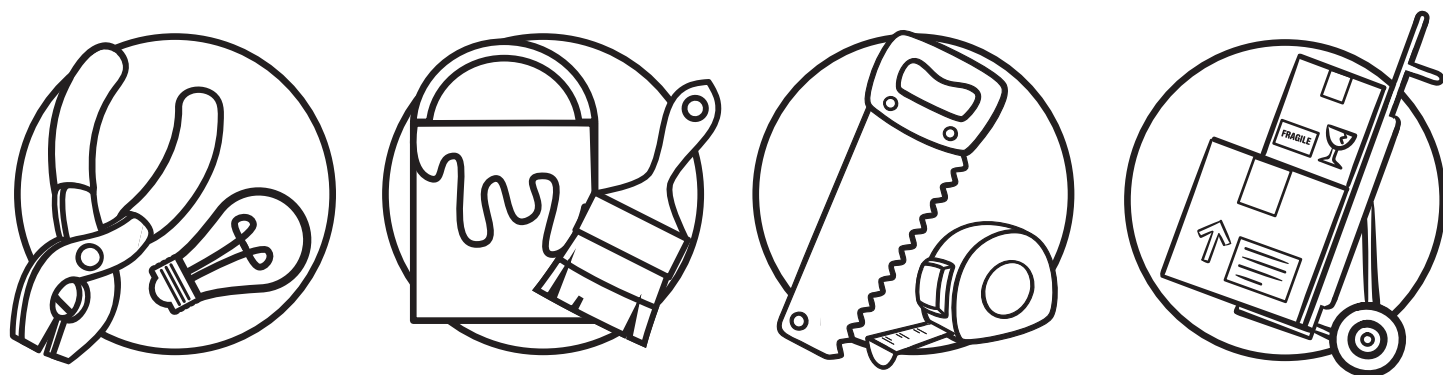
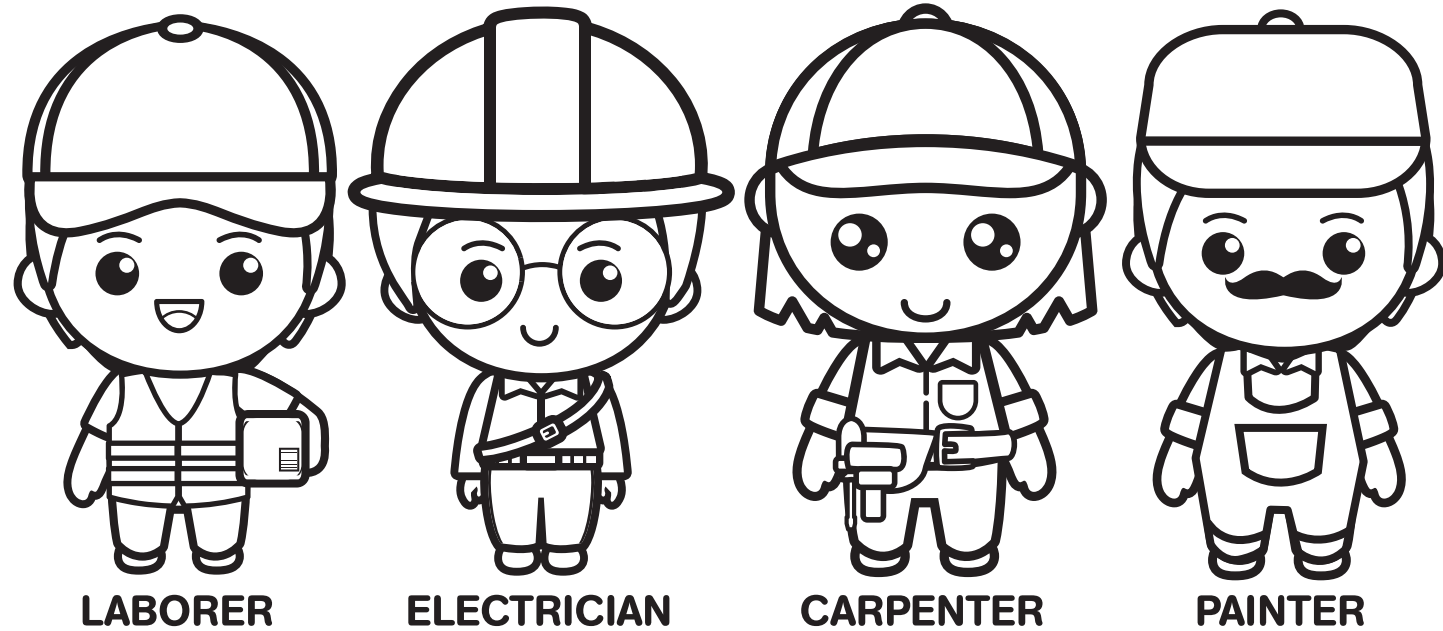

MEET BESSIE COLEMAN.

DID YOU KNOW?

In 1915, **Bessie Coleman** lived in Chicago working as a manicurist at the White Sox Barber Shop. There, she heard stories of flying from pilots returning home from World War I.

This interested Bessie so much that she traveled to Paris to earn her pilot's license. In 1921, she became the first Black woman and first Native American to earn an international aviation license. Bessie then returned to America where she became a media sensation, often being called "Queen Bess" and "Brave Bessie."

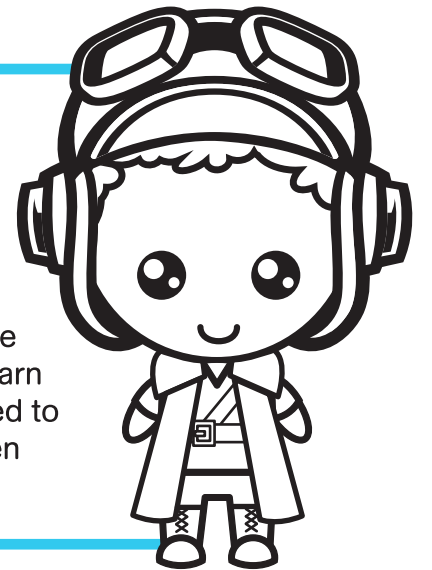

Can you get Bessie Coleman from Chicago to Paris?



START HERE

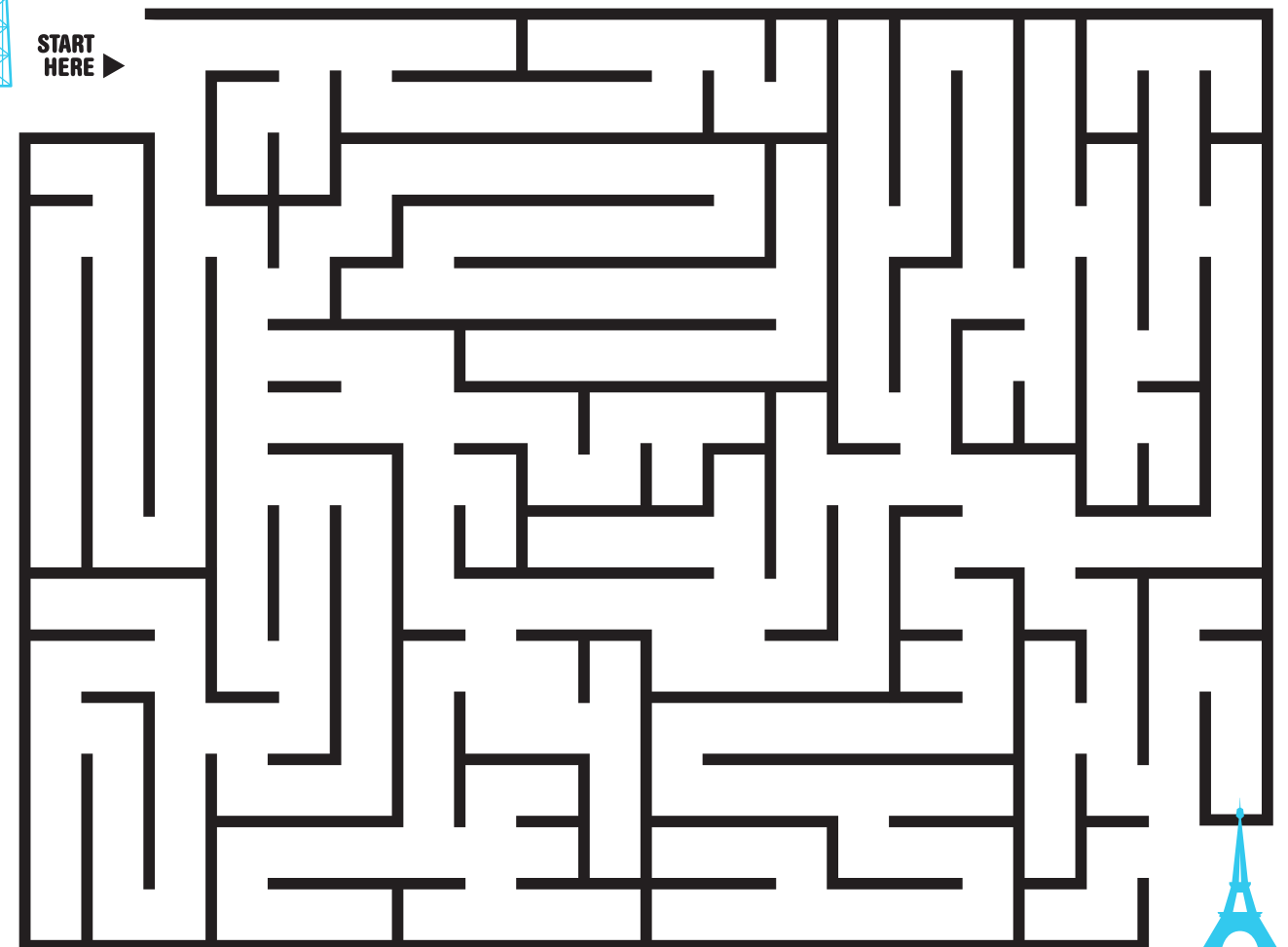

WILLA BROWN & THE TUSKEGEE AIRMEN.

DID YOU KNOW

Willa Brown, an extraordinary Chicagoan, was the very first Black woman to earn a pilot's license in the United States.

In 1940, just before the U.S. entered World War II, the country had a serious shortage of pilots. Willa Brown had the answer: train young Black men to fly for the military. Nearly 200 students she trained at her flight school went on to join the Tuskegee Airmen, the first Black fighter pilots and crew in the U.S. Army Air Corps.

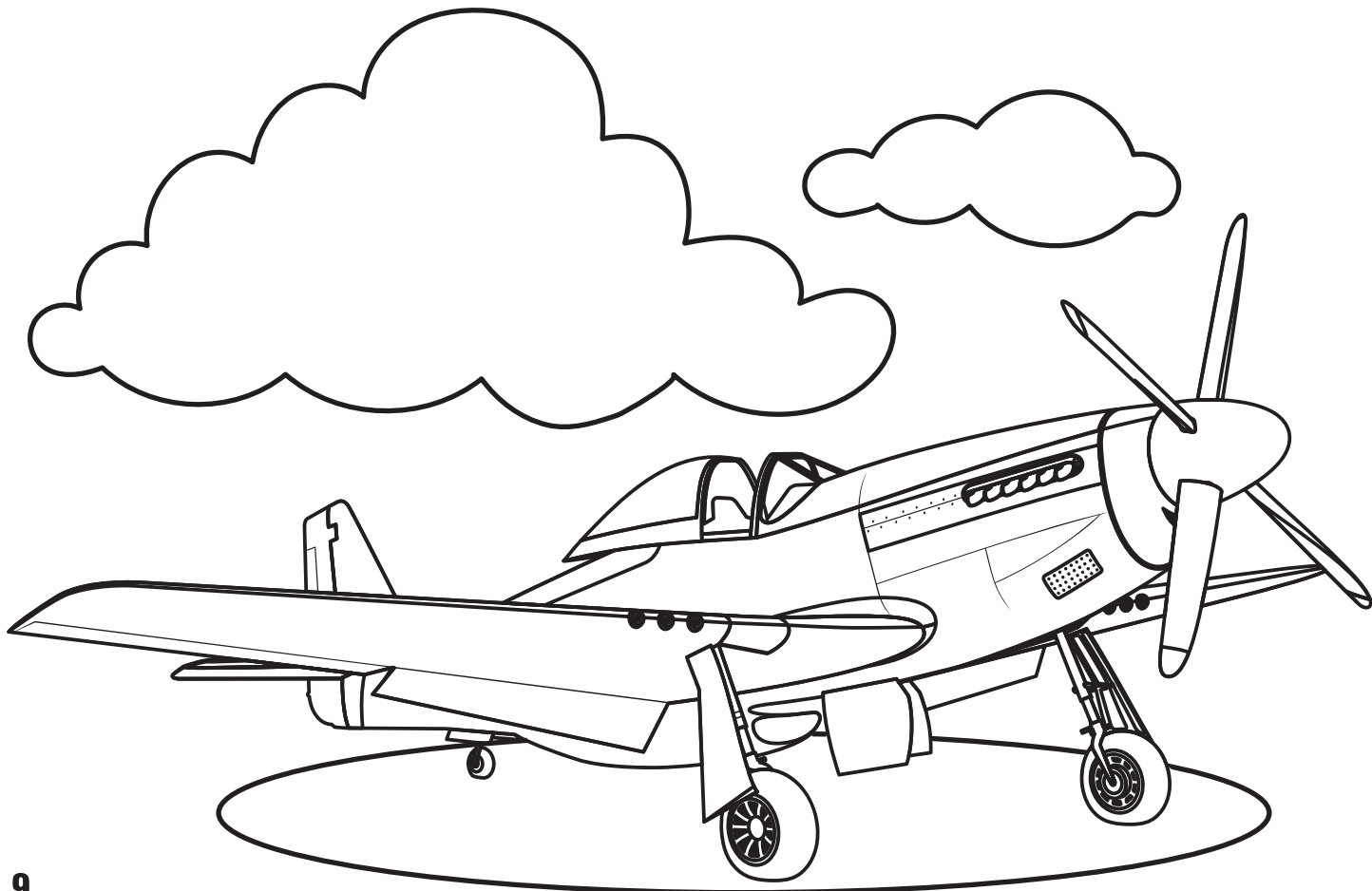

MEET ELLEN OCHOA.

DID YOU KNOW

Ellen Ochoa was the first Hispanic woman to go to space on a nine-day mission aboard the Space Shuttle Discovery in 1993. She was also the first Hispanic director and the second female director of the Johnson Space Center.

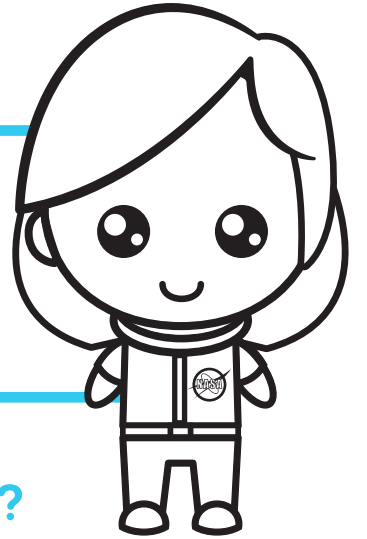

Can you find all the listed words hidden in the box?

1. Astronaut
2. Female
3. Earth
4. Hispanic
5. Engineer
6. Mission
7. NASA
8. Ochoa
9. Spacecraft

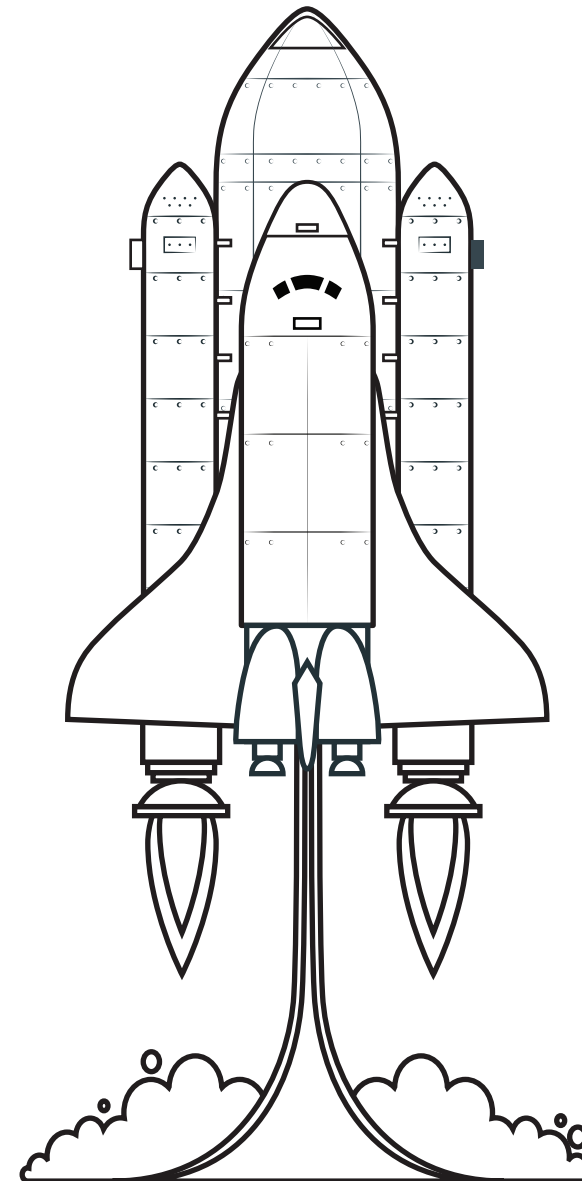

| | | | | | | | | | |
|---|---|---|---|---|---|---|---|---|---|
| S | O | C | H | O | A | H | V | Y | U |
| A | P | H | I | S | P | A | N | I | C |
| E | S | A | F | J | X | V | I | I | G |
| N | M | T | C | F | E | M | A | L | E |
| G | I | Q | R | E | N | D | L | I | Q |
| I | S | Q | E | O | C | A | K | D | L |
| N | S | X | A | T | N | R | S | W | N |
| E | I | Q | R | G | K | A | A | A | Q |
| E | O | A | T | O | L | M | U | F | R |
| R | N | H | H | Z | Z | P | N | T | T |

FLY AROUND THE WORLD.

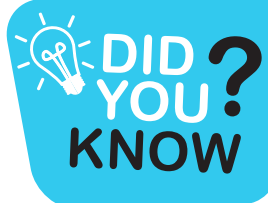

Planes from O'Hare and Midway Airports fly to nearly 60 different international destinations around the world!

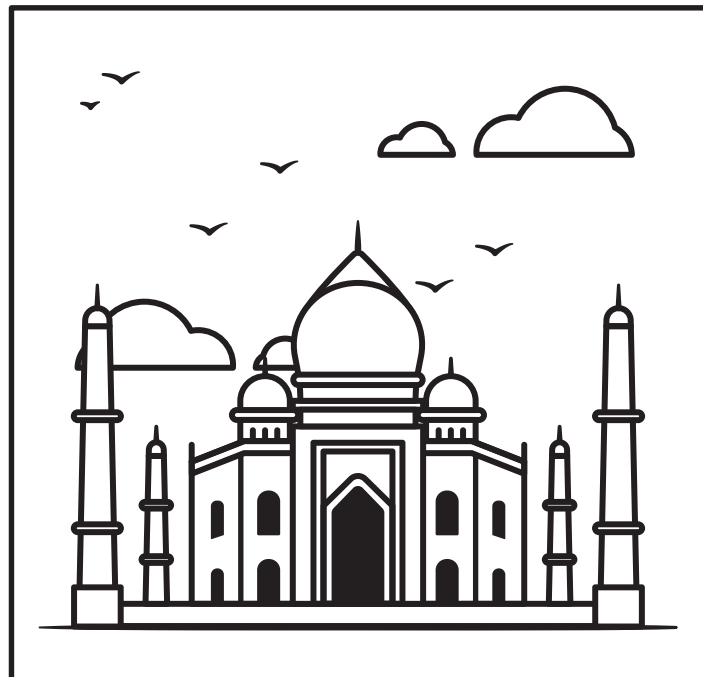

CROSSWORD PUZZLE.

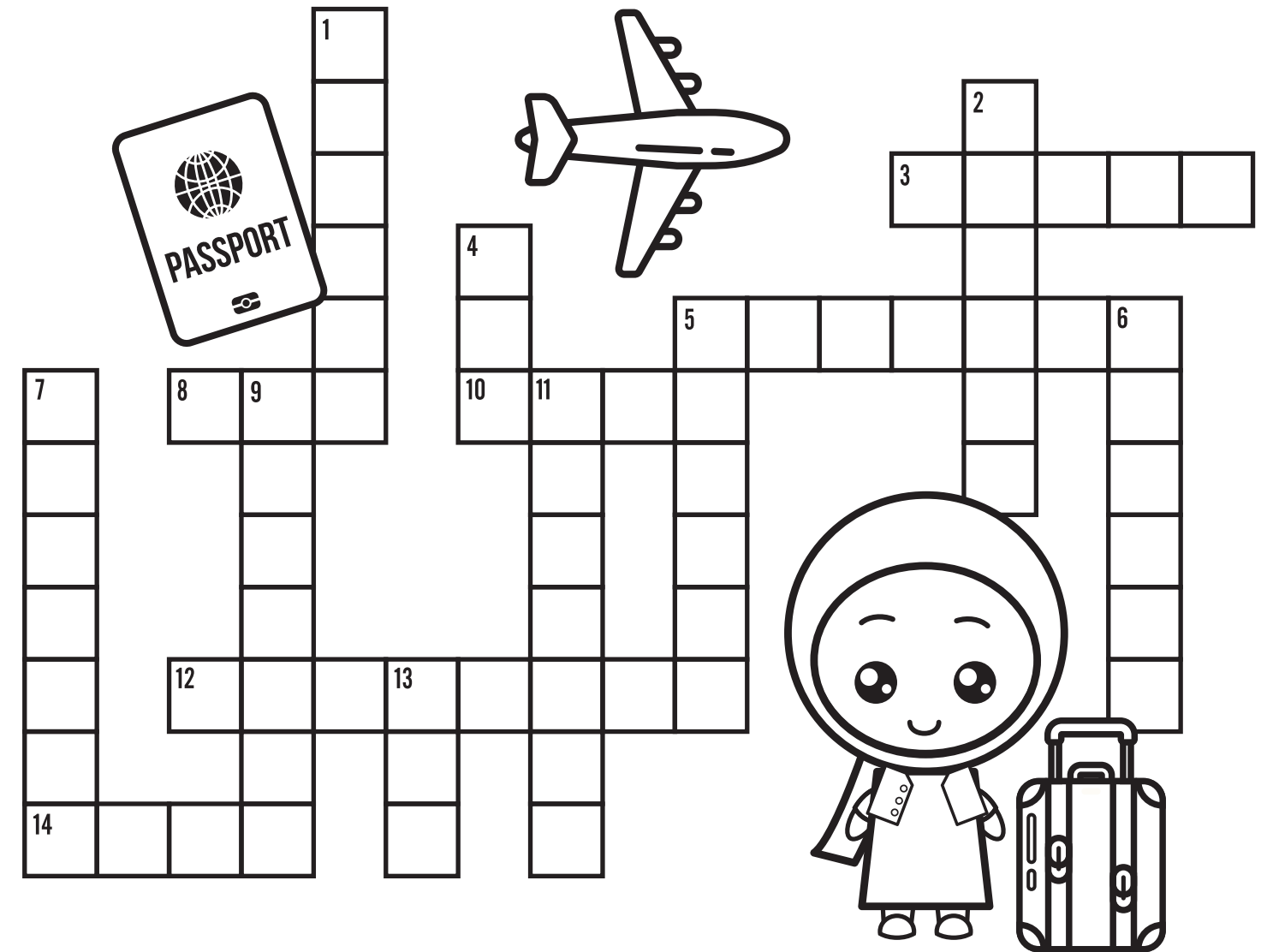

ACROSS

- 3. A plane has two of these
- 5. This is the start of a flight
- 8. Birds and planes do this
- 10. Planes do this before takeoff
- 12. You need this to enter another country
- 14. Where you board the plane

DOWN

- 1. Where planes takeoff
- 2. They fly the plane
- 4. Another word for a plane
- 5. You buy this to get on a plane
- 6. You go to the gate to board your...
- 7. This is the end of a flight
- 9. You pack your clothes in this
- 11. This place has planes and runways
- 13. Where you are when you fly

ANSWERS: ACROSS: 3. wings 5. takeoff 8. fly 10. taxi 12. passport 14. gate
DOWN: 1. runway 2. pilots 4. jet 5. ticket 6. flight 7. landing 9. luggage 11. airport 13. sky

TAKE THE TRAIN TO & FROM THE AIRPORT.

DID YOU KNOW?

- The Blue Line is a 26.93-mile-long (43.34 km) Chicago 'L' line that travels between the downtown Loop and O'Hare Station.
- The Blue Line is the longest line of the CTA 'L' train system and second busiest.

DID YOU KNOW?

- The Orange Line is approximately 13 miles (21 km) long running from the downtown Loop to Midway Station.
- The Orange Line opened for service on October 31, 1993, and was the first extension to the CTA system since the O'Hare Airport Extension of the Blue Line in September 1984.

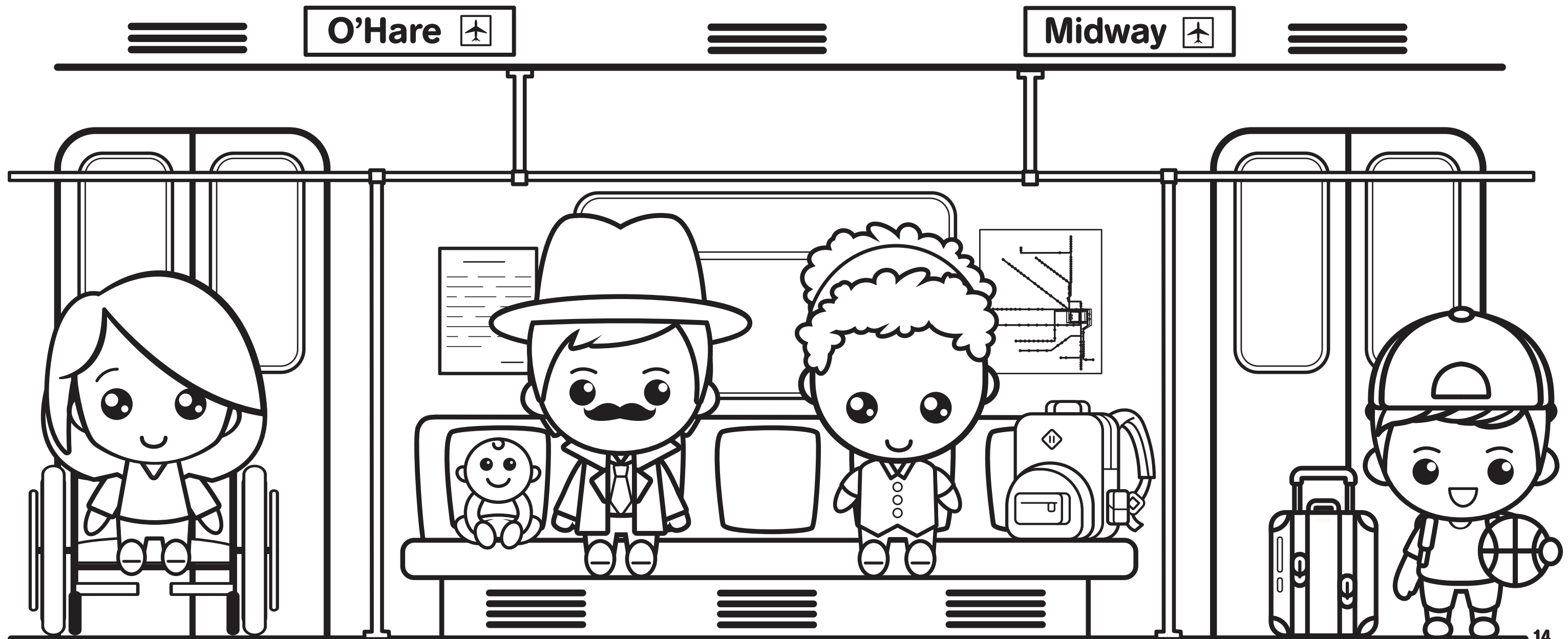

Humboldt Park

The Puerto Rican community in **Humboldt Park** holds yearly parades and festivals with plenty of food, dancing and vendors keeping the heritage alive. You can also visit the National Museum of Puerto Rican Arts and Culture, built in 1895. It is one of the oldest surviving buildings in Humboldt Park and was used to hold horses and landscape equipment.

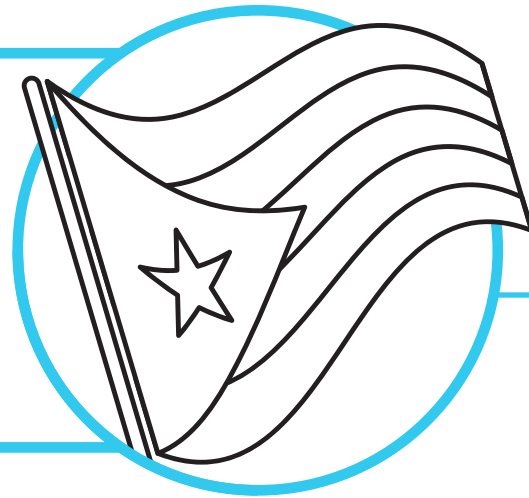

Pilsen

Pilsen is a Mexican American neighborhood that is definitely worth a visit! Aside from its great food, it is also known for the murals and mosaics that are spread throughout the neighborhood. You can also visit the National Museum of Mexican Art for a trip through Mexican artwork and artists from past to present.



Chinatown

This is absolutely a spectacular place to see and you can get there by car or by water taxi. Chinatown Square is the center of the action in **Chicago's Chinatown**. Here you'll be able to try Chinese food from a number of different restaurants or visit shops where you can buy Chinese herbs, knick-knacks, and all sorts of other goods.



Bronzeville

Historically known as the Black Metropolis, **Bronzeville** is the center for African American culture in Chicago. On Dr. Martin Luther King Jr. Drive is the home of civil rights activist Ida B. Wells. You can also see the Monument to the Great Northern Migration, honoring the African Americans who traveled from the South to Chicago between 1910 to 1970.

A FEW PLACES TO VISIT.

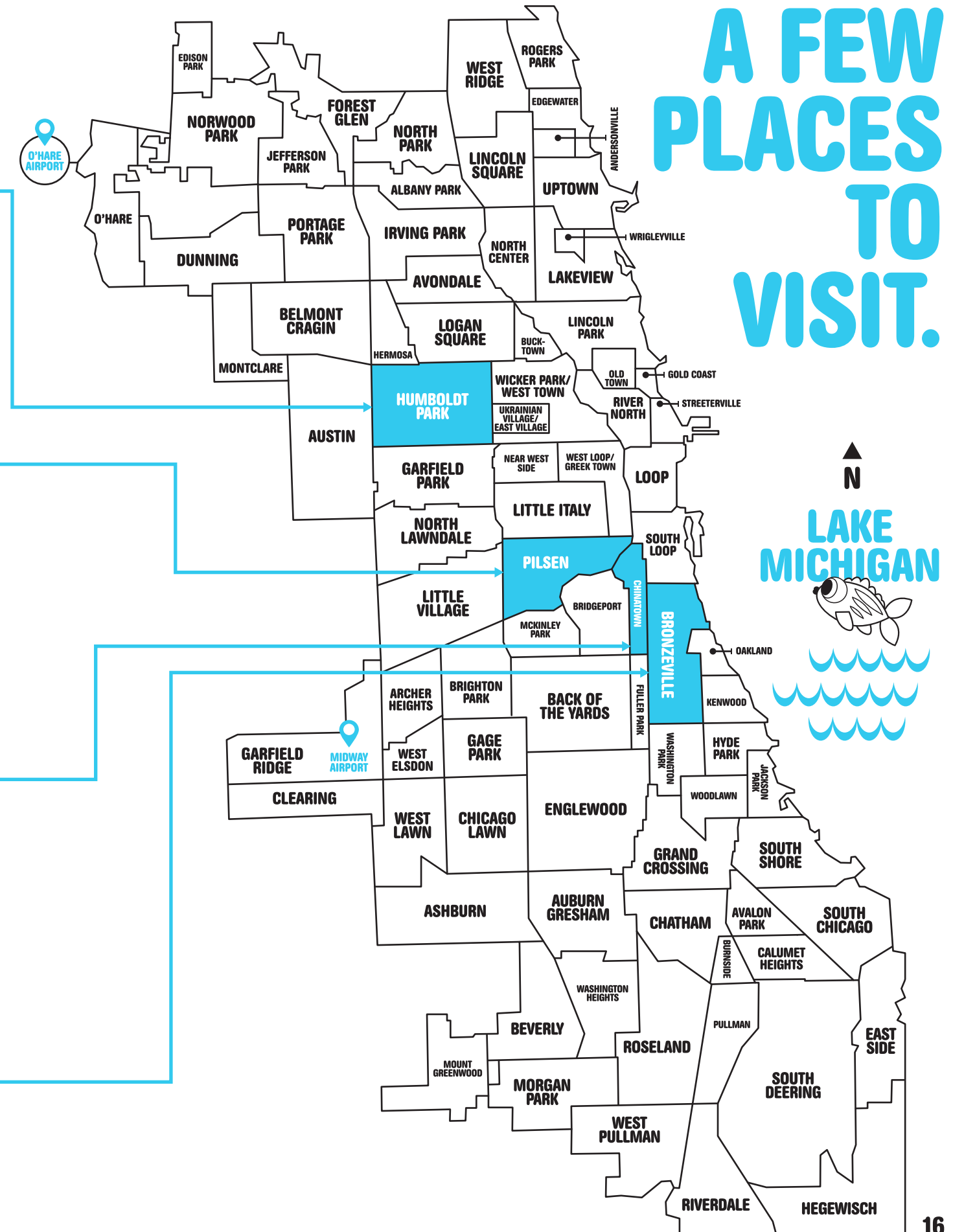

WORD SEARCH.

DID YOU KNOW?

Every summer, over 130 animals including sheep, goats, burros and llamas eat away the grass at O'Hare Airport. This grazing herd is a very green way to cut the lawn!

O'Hare is also home to over 250,000 honeybees. Their beehives are called an apiary and the honey they make is sold at both O'Hare and Midway airports.

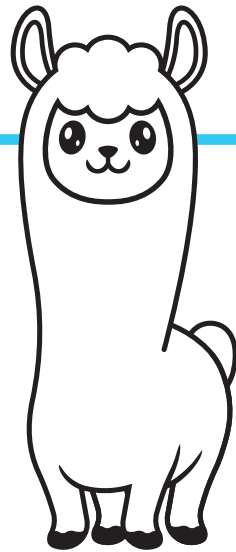
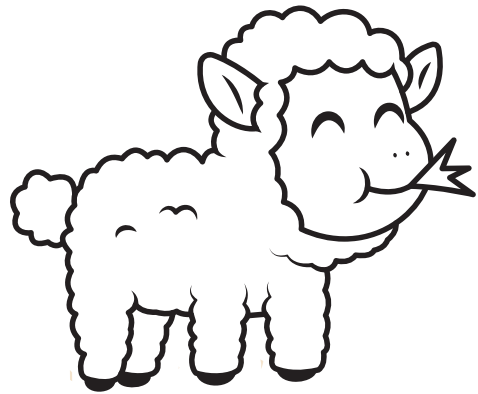

Can you find all the listed words hidden inside the box?

1. Apiary
2. Beehive
3. Burro
4. Green
5. Herd
6. Honey
7. Honeybee
8. Llama
9. Recycle
10. Sheep
11. Shepherd

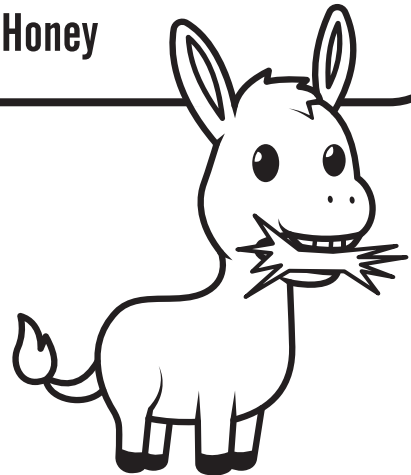

| | | | | | | | | | |
|---|---|---|---|---|---|---|---|---|---|
| M | L | E | A | B | U | R | R | O | C |
| Q | H | E | R | D | T | Y | Q | Q | U |
| Z | J | W | R | H | O | N | E | Y | F |
| A | B | S | H | E | P | H | E | R | D |
| P | E | B | T | K | C | L | K | H | G |
| I | E | S | S | Q | K | Y | Q | T | Y |
| A | H | S | H | E | E | P | C | Y | U |
| R | I | G | R | E | E | N | U | L | A |
| Y | V | H | O | N | E | Y | B | E | E |
| A | E | W | P | C | L | L | A | M | A |

AIRPORT FUN FACTS.

O'HARE INTERNATIONAL AIRPORT



1945 THE YEAR O'HARE OPENED

OVER 215 RESTAURANTS & SHOPS

300 SNOW PLOWS & TRUCKS



201 GATES

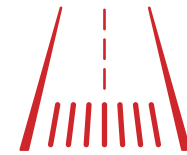

8 OPERATING RUNWAYS

MIDWAY INTERNATIONAL AIRPORT



1927 THE YEAR MIDWAY OPENED

OVER 55 RESTAURANTS & SHOPS

66 SNOW PLOWS & TRUCKS



43 GATES

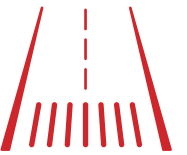

5 OPERATING RUNWAYS



O'HARE & MIDWAY
— INTERNATIONAL AIRPORTS — ✈

flychicago.com/JrFlightCrew
#JrFlightCrew



fly2ohare
fly2midway



HELLO FROM
CHICAGO

